



Mesa Estribo



Base Metalica Peltre Brillante
Pata de Madera Álamo
Tapa Perlado Exótico



MODELO: Mesa Estribo

COLECCIÓN: De Río a Sur

DIMENSIONES:

Standard: L200cm x A100cm x H75cm

A Medida: L(según material) x A120cm x H75cm

TERMINACIONES DEL MATERIAL

Tapa:

Mármol Nacional:



Matizado Texturado



Negro Texturado



Rosa Texturado

Mármol Importado:



Verde Exótico



Gris Exótico



Perlado Exótico

Estructura Metálica:



Negro Micro



Cobre Brillo



Bronce Brillo



Peltre Brillo

Base de Madera:



Álamo



ESPECIFICACIONES TÉCNICAS

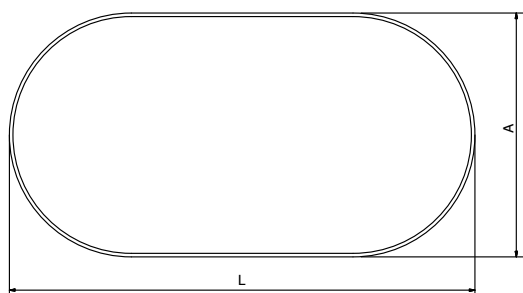
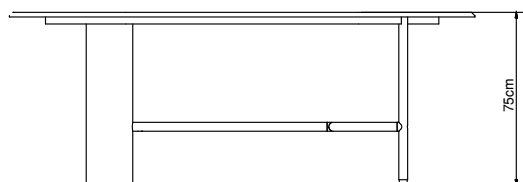

MATERIAL:

Tapa: Marmoles Nacionales e Internacionales

Estructura de Hierro

Base de Madera Álamo

AMBIENTE: Interior y Exterior

FECHA DE ACTUALIZACIÓN: 06/05/2021



MODELO: Estribo Ovalada Baja

COLECCIÓN: De Río a Sur

DIMENSIONES: 120cm x 50cm x 43cm

PESO: Kg.

TERMINACIONES DEL MATERIAL:

Estructura:

Patas:



Núcleo:

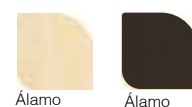

Tapa:

Mármol Nacional:

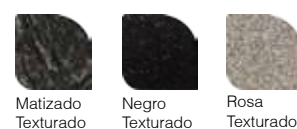

Mármol Importado:

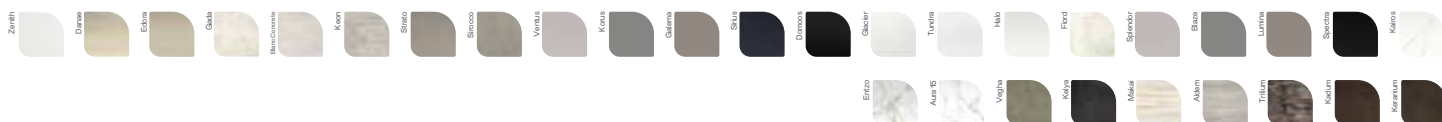
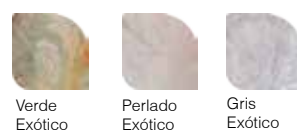

Nota: Para detalle de terminaciones solicitar "Catálogo de Acabados".

ESPECIFICACIONES TÉCNICAS

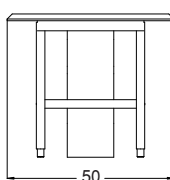
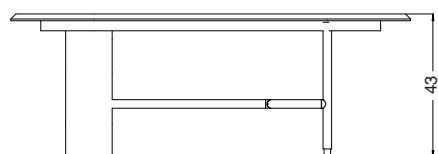
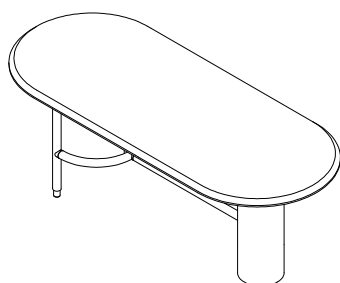
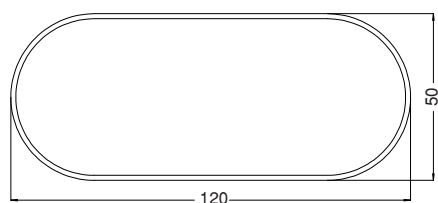

MATERIAL:

Tapas: De acuerdo a la terminación: Mármol Nacional, o Marmol Importado.

Patas: Caño de Hierro

Núcleo: Madera de Álamo

AMBIENTE: Interior

FECHA DE ACTUALIZACIÓN: 30/01/2020



MODELO: Estribo Circular Baja

COLECCIÓN: De Río a Sur

DIMENSIONES: Ø90cm x 53cm

PESO: Kg.

TERMINACIONES DEL MATERIAL:

Estructura:

Patas:



Núcleo:

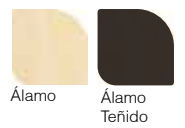

Tapa:

Mármol Nacional:

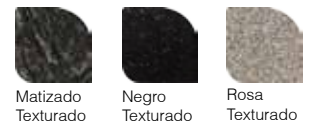

Mármol Importado:

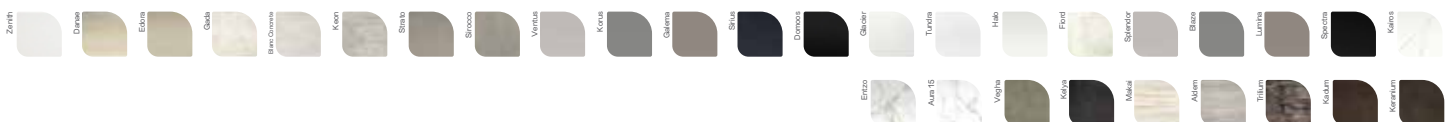

ESPECIFICACIONES TÉCNICAS

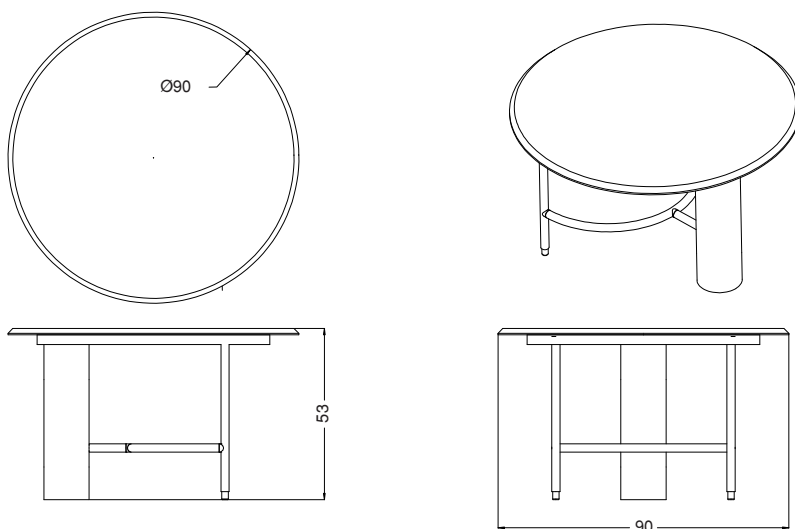

MATERIAL:

Tapas: De acuerdo a la terminación: Mármol Nacional, o Marmol Importado.

Patas: Caño de Hierro

Núcleo: Madera de Álamo

AMBIENTE: Interior

FECHA DE ACTUALIZACIÓN: 30/01/2020